

Klipsch

MODE



M40 OWNER'S MANUAL

Welcome to Klipsch. Listen with Passion.

Congratulations on your purchase and thank you for selecting Klipsch MODE headphones. These active noise cancelling headphones have been crafted with the finest materials - high-grade leather, professional grade memory foam, HiFi inspired woven cables and high-strength polymers - to create a product unmatched in the industry for superior quality and comfort, with the audio performance you would expect from Klipsch.

As a Klipsch headphone owner, you belong to an elite circle of highly discerning listeners that's 65 years in the making. Every product we make - from headphones to home theater - reflects our no-compromise attitude and commitment to delivering the industry's most powerful, detailed and emotional sound experience.

Your Klipsch MODE headphones have been designed and manufactured to the highest quality standards. Each pair undergoes rigorous testing before leaving the factory and comes with a limited two-year warranty. This attention to detail guarantees years of reliable performance. We hope these headphones bring new life to your music and years of comfortable listening.

Register your product today at [klipsch.com/register](https://www.klipsch.com/register)

Important Safety Information

- 1) READ these instructions.
- 2) KEEP these instructions.
- 3) HEED all warnings.
- 4) FOLLOW all these instructions.
- 5) If you hear ringing or experience pain or discomfort in your ears during or after using any headphone audio product, that is a sign you are listening too loud. When your ears are exposed to high volumes (in excess of 85dB) for over an hour, you may be permanently damaging your hearing.
- 6) Turn down your listening device's volume to zero before you insert the Klipsch headphones and turn on the device. Once you have the headphones in, gradually increase the volume to a comfortable, moderate volume.
- 7) Clean your headphones with an antiseptic wipe. This improves the acoustic quality of your headphones.
- 8) NEVER operate a motor vehicle while listening to or wearing your headphones. Not only dangerous, it is illegal in many places.
- 9) NEVER operate heavy machinery while listening to or wearing your headphones.
- 10) We don't recommend you use the headphones while riding a bicycle, running, or walking in heavy traffic areas. If you do, listen at a lower volume so you can hear ambient noise.

WARNING:

Except in case of emergency, Klipsch Group, Inc. (KGI) recommends you do not use these headphones or headsets (headphones plus microphone) as aviation communication equipment as they are not engineered for many environmental conditions common in commercial or non-commercial aircraft (including, but not limited to: altitude, temperature, noise conditions, unpressurized aircraft, etc.) resulting in possible interference to critical communications. The Occupational Safety Health Administration (OSHA) has issued headphone usage recommendations for maximum daily exposure and sound pressure levels (measured in decibels (dB)). A decibel is a unit of measure of sound, and decibels increase exponentially as sound gets louder. For example, conversational speech is typically around 60dB, and a rock concert in a stadium is often about 110dB.

“Made for iPod,” “Made for iPhone,” and “Made for iPad” mean that an electronic accessory has been designed to connect specifically to iPod, iPhone, or iPad, respectively, and has been certified by the developer to meet Apple performance standards. Apple is not responsible for the operation of this device or its compliance with safety and regulatory standards.

OSHA Guidelines for Noise Exposure Limits

| Sound Pressure Level | Recommended Maximum Exposure Per Day |
|----------------------|--------------------------------------|
| 90dB | 8 hours |
| 95dB | 4 hours |
| 100dB | 2 hours |
| 105dB | 1 hours |
| 110dB | 30 minutes |
| 115dB | 15 minutes |
| 120dB | Avoid as damage may occur |

EU COMPLIANCE INFORMATION

Eligible to bear the CE mark, Conforms to European Union EMC Directive 2004/108/EC.

WEEE NOTICE

Note: This mark applies only to countries within the European Union (EU) and Norway. This appliance is labeled in accordance with European Directive 2002/96/ EC concerning waste electrical and electronic equipment (WEEE). This label indicates that this product should not be disposed of with household waste. It should be deposited at an appropriate facility to enable recovery and recycling.

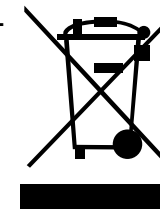

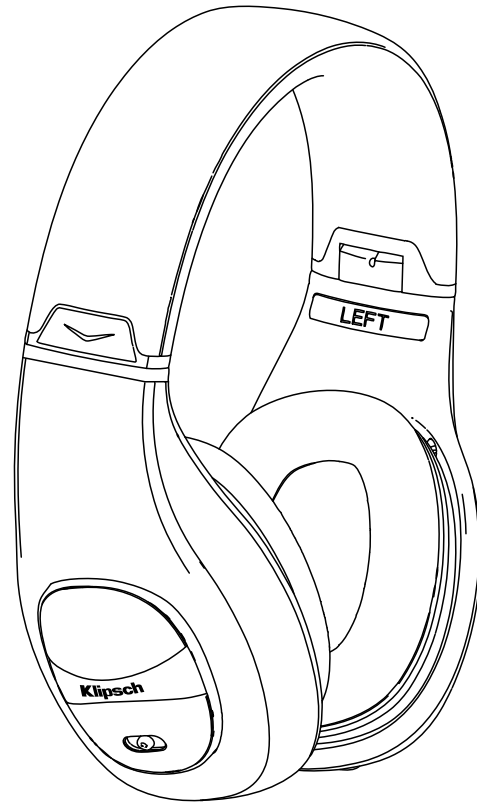

Klipsch Mode headphones

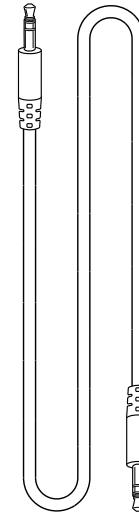

Standard headphone cable



AAA battery

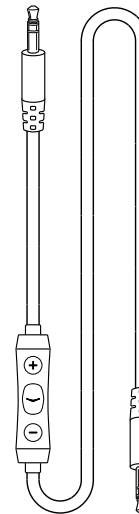

Apple 3-button controller cable

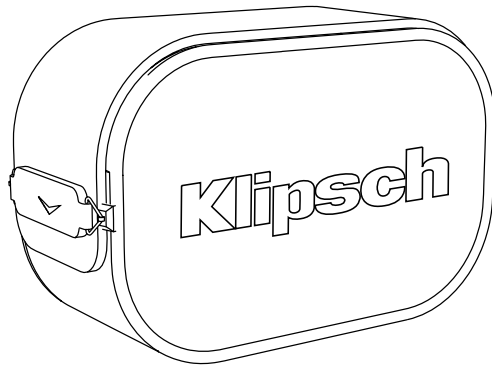

Leather carrying case

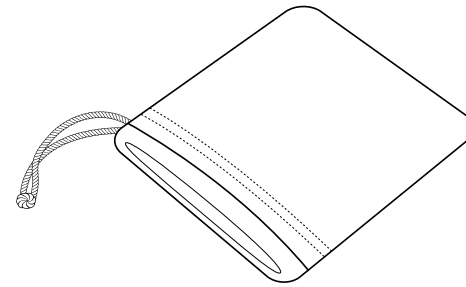

Microfiber carrying case

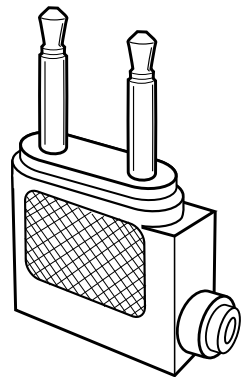

Airline adapter

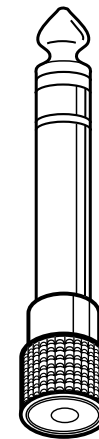

1/4" Stereo adapter

CABLES

Klipsch Mode headphones are compatible with all audio sources with a 3.5mm headphone jack using the included standard headphone cable.

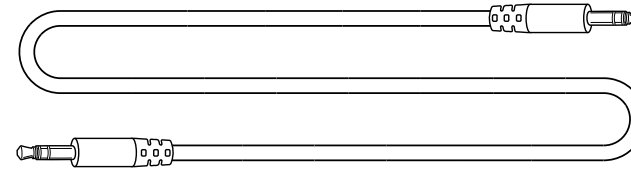

The included Apple 3-button controller cable provides enhanced functionality with compatible Apple devices. See chart below for complete compatibility.

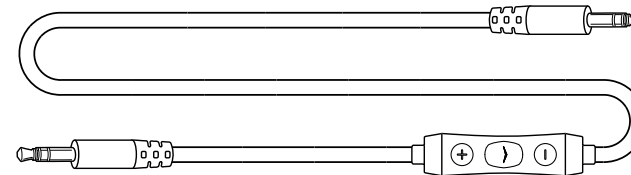

This accessory works with the following (Audio is supported by all iPod models):

- iPhone 4
- iPhone 3GS
- iPod touch (4th generation)
- iPod touch (3rd generation)
- iPod touch (2nd generation)
- iPod classic (120GB, 160GB)
- iPod nano (6th generation)
- iPod nano (5th generation)
- iPod nano (4th generation)
- iPod shuffle (4th generation)
- iPod shuffle (3rd generation)
- iPad
- iPad 2



Visit Klipsch.com
for latest compatibility info.

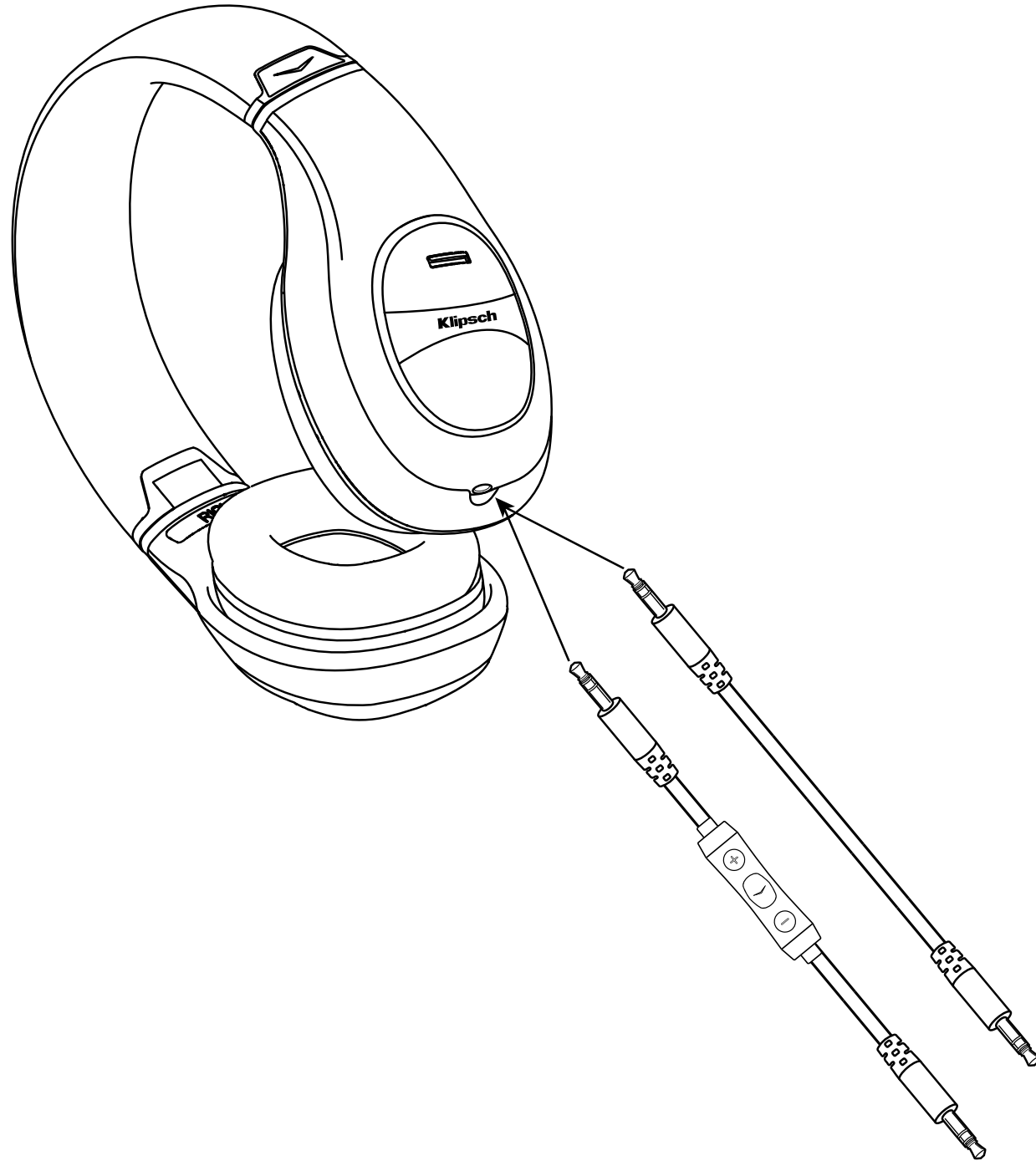

1/4" STEREO ADAPTER

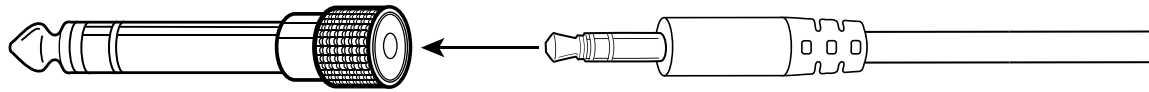

BATTERY INSTALLATION

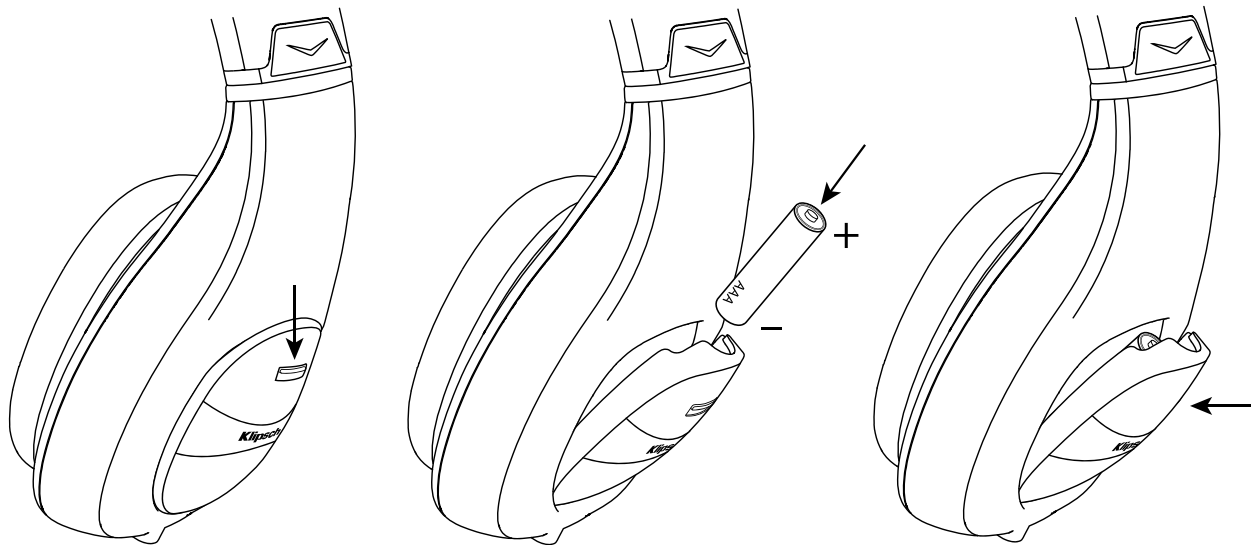

BATTERY LIFE & REPLACEMENT BATTERY

While it will vary by usage, battery life will average around 45 hours. The power indicator light will begin flashing when there is approximately 10% battery life remaining.

NOISE CANCELLING

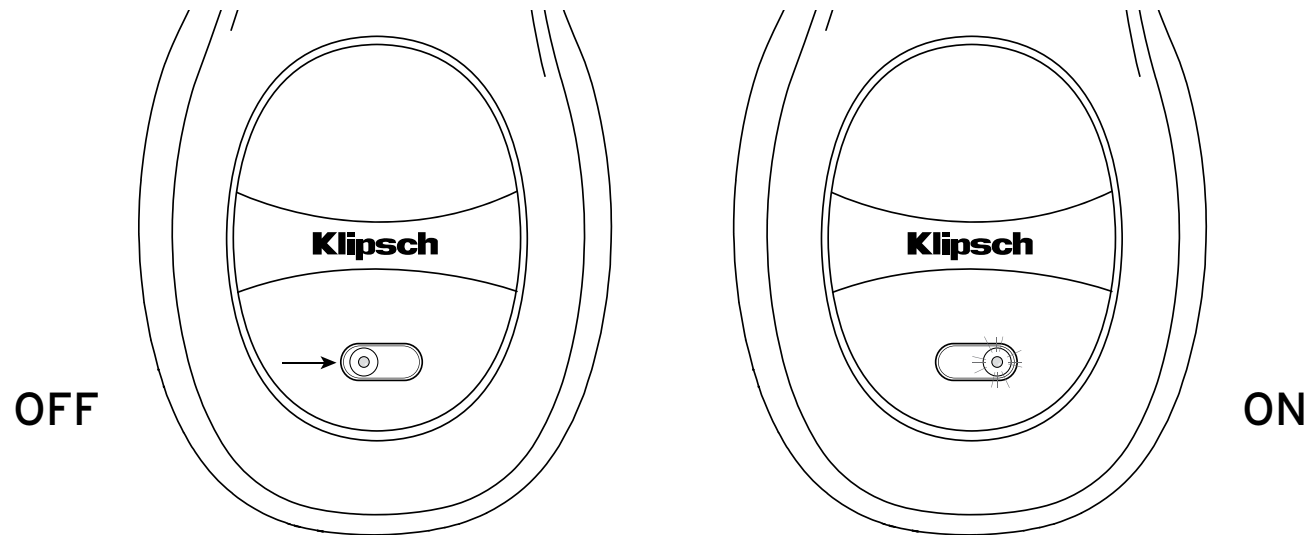

Audio source with noise cancelling

To use the headphone with noise cancelling, connect the headphone to an audio source and move the power switch forward to the on position. The power indicator will illuminate red when noise cancelling is powered on.

Audio Source without noise cancelling

Klipsch Mode headphones have the ability to function without noise cancelling turned on. Simply connect one of the included cables to an audio source and use with the power switch in the off position. There may be reduction in bass quality when used without noise cancelling.

Noise cancelling only

The noise cancelling function can be used without a music source to block out ambient noise. When using noise cancelling without music, there is no need to connect a cable.

REATTACHING EARCUPS

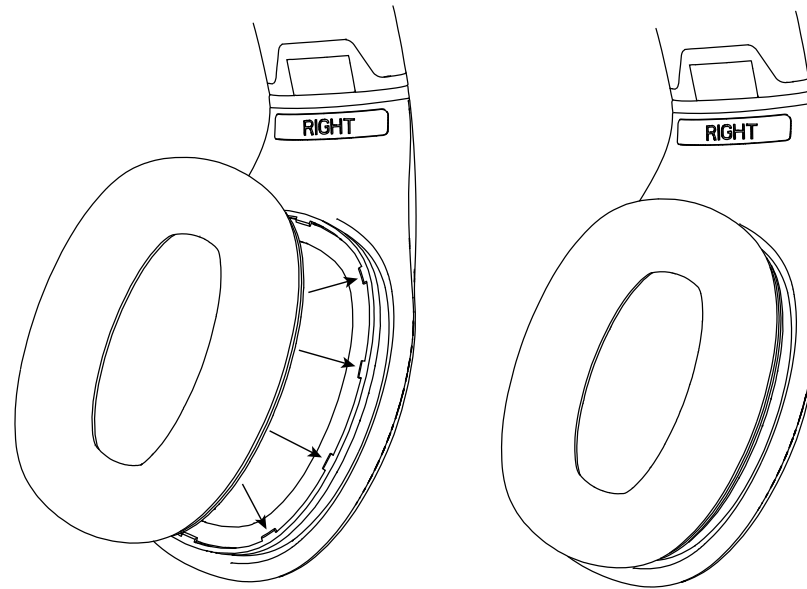

STORING THE HEADPHONES

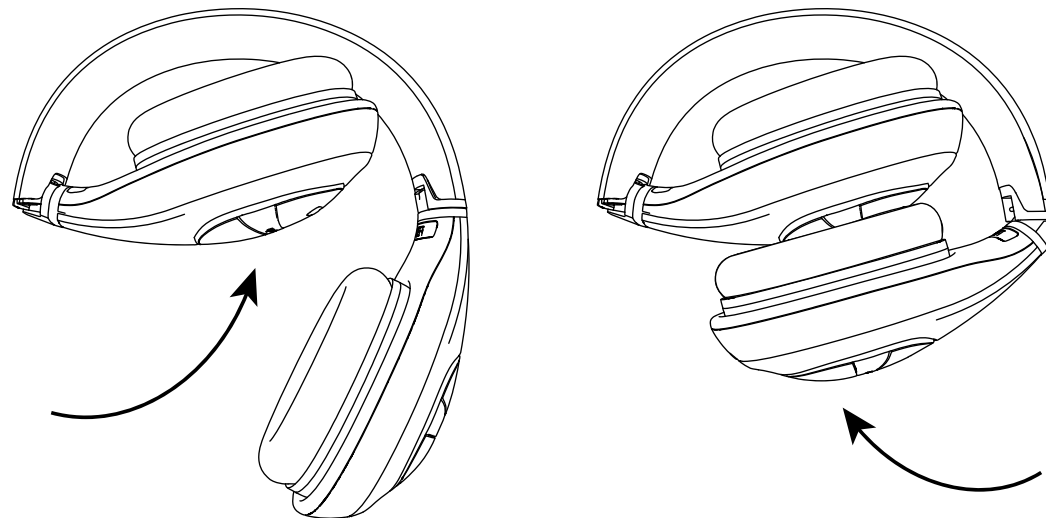

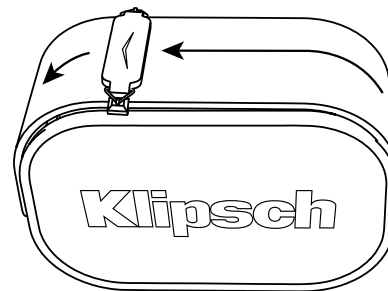
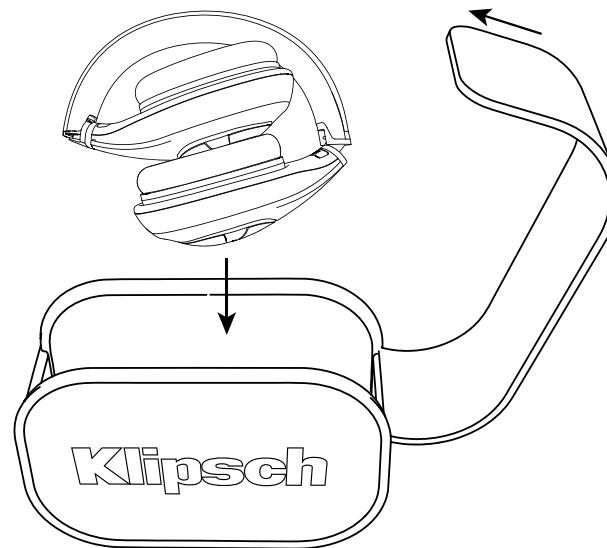
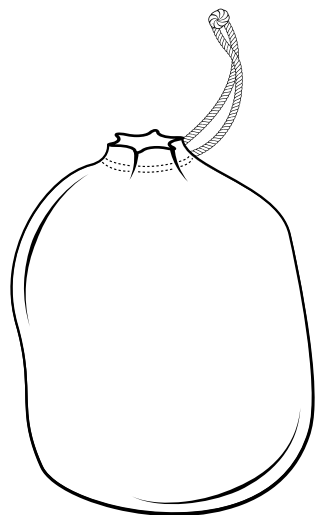
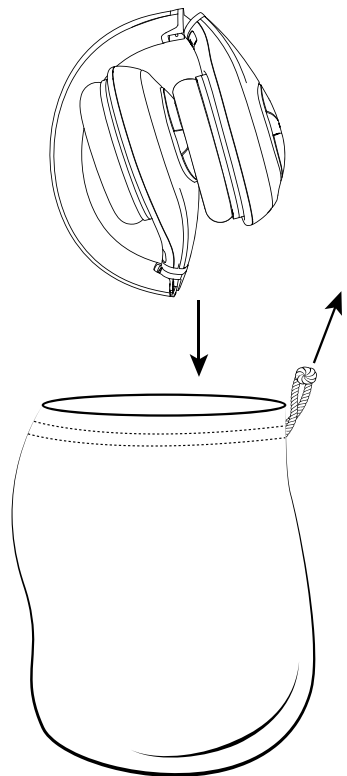

USING WITH IN-FLIGHT ENTERTAINMENT SYSTEMS

Audio jack configurations on airplanes vary. Note jack configurations in the chart below:



A single, 3.5 mm jack

No adapter needed.

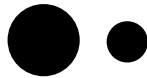

One 3.5 mm jack and one power jack

Use the single plug in the 3.5 mm jack.
The power jack does not need a connection.



Two 3.5 mm jacks

Use the included airline adapter

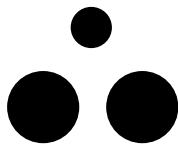

One power jack and two 3.5 mm jacks

Use the included airline adapter for the two 3.5 mm jacks.
The power jack does not need a connection.

TROUBLESHOOTING

Low or no volume

Check that audio source is powered on and that the volume is turned up.

Check that the audio cable is properly connected and not damaged.

The headphones will not work if the power is switched on and the battery is fully discharged. Replace AAA battery or use with power switch in the off position.

No noise cancelling

Check that power switch is in on (forward) position.

Replace AAA battery.

Sound in one side only or crackling sound

Check that the audio cable is properly connected and not damaged.

Power indicator flashing

Replace AAA battery.

WARRANTY - U.S. AND CANADA

Klipsch Group, Inc. (KGI) warrants to the original retail purchaser that the headphones shall be free against defects in materials or workmanship in the product's headphone external shell or in its headphone internal components for a period of two (2) years, from the date of purchase, if it is properly used and maintained. If this product proves defective in either material or workmanship, KGI, at its option, will (a) repair the product, or (b) replace the product, at no charge for parts or labor. If the product model is no longer available and cannot be repaired effectively or replaced with an identical model, KGI at its sole option may replace the unit with a current model of equal or greater value. To obtain a repair or replacement under the terms of this warranty, please contact our customer service group at 1-800-KLIPSCH. You will be required to submit a copy of the original receipt via fax or email. The receipt must reflect that you are the original purchaser, the product was bought from an authorized KGI retailer, and the product is still within warranty. You will be issued a return authorization number (RA#) and asked to ship the defective product, together with proof of purchase and RA#, prepaid insured to the following address: Klipsch Group, Inc. • 137 Heampstead #278 • Hope, AR 71801. Freight collect shipments will be refused. Risk of loss or damage in transit is to be borne by the purchaser. Once KGI receives the defective product, a repair or replacement will be initiated.

Limitations:

- This limited warranty does not cover failure of the product resulting from misuse, abuse, accident, neglect, mishandling, or wear from ordinary use or environmental deterioration.
- This limited warranty does not cover consequential damage to other components including headphone cable, adaptor jack, cleaning tool, airplane adaptor, additional ear tips, large or small carrying case. No such other components or accessories of the product are covered by this limited warranty. In addition, this limited warranty does not apply to any non-Company hardware product or any software; even if package is sold with the product.
- This limited warranty is null and void for products altered or missing serial numbers and for products not purchased from an authorized dealer.
- This limited warranty terminates if you sell or otherwise transfer this product to another party.

THIS WARRANTY GIVES YOU SPECIFIC LEGAL RIGHTS. YOU MAY ALSO HAVE OTHER RIGHTS, WHICH CAN VARY FROM STATE TO STATE, JURISDICTION TO JURISDICTION AND COUNTRY TO COUNTRY. KGI'S RESPONSIBILITY FOR MALFUNCTIONS AND DEFECTS IN HARDWARE IS LIMITED TO REPLACEMENT OR REPAIR AS SET FORTH IN THIS WARRANTY STATEMENT. FOR US AND CANADIAN CUSTOMERS, KGI DISCLAIMS ALL EXPRESS AND IMPLIED WARRANTIES FOR THE PRODUCT, INCLUDING BUT NOT LIMITED TO ANY IMPLIED WARRANTIES OF MERCHANTABILITY AND FITNESS FOR A PARTICULAR PURPOSE. KGI DOES NOT ACCEPT LIABILITY FOR SPECIAL, INDIRECT, CONSEQUENTIAL OR INCIDENTAL DAMAGES, INCLUDING WITHOUT LIMITATION, ANY LIABILITY FOR THIRD PARTY CLAIMS AGAINST YOU FOR DAMAGES OR FOR PRODUCT NOT BEING AVAILABLE FOR USE. THE MAXIMUM LIABILITY FOR WHICH KGI MAY BE RESPONSIBLE WILL BE NO MORE THAN THE AMOUNT YOU PAID FOR THE PRODUCT THAT IS THE SUBJECT OF THE CLAIM. SOME STATES, JURISDICTIONS OR COUNTRIES DO NOT ALLOW THE EXCLUSION OF CERTAIN IMPLIED WARRANTIES OR CONDITIONS, LIMITATIONS ON HOW LONG AN IMPLIED WARRANTY OR CONDITION LASTS, AND/OR THE EXCLUSION OR LIMITATION OF SPECIAL, INDIRECT, INCIDENTAL OR CONSEQUENTIAL DAMAGES, SO THE ABOVE LIMITATION OR EXCLUSION MAY NOT APPLY TO YOU.

WARRANTY OUTSIDE THE U.S. AND CANADA

The Warranty on this product if it is sold to a consumer outside of the United States and Canada shall comply with applicable law. To obtain any applicable warranty service, please contact the dealer from which you purchased this product, or the distributor that supplied this product.

iPhone, iPod, iPod classic, iPod nano, iPod shuffle, and iPod touch are trademarks of Apple Inc., registered in the U.S. and other countries. iPad is a trademark of Apple Inc.

Klipsch is a registered trademark of Klipsch Group, Inc.

Klipsch®

3502 WOODVIEW TRACE, INDIANAPOLIS, IN, USA

klipsch.com

©2011, Klipsch Group, Inc.